





UNIT CODE	DESCRIPTION
C-SDR 480-48	480 Watt, 48V, Single Output Compact DIN RAIL Power Supply with PFC, <b>GL</b> and <b>SEMI F47</b> approved

SPECIFICATIONS		
Input	Output	Agency Approvals
Universal AC Input 88~264VAC	+48VDC @ 0 ~ 10A	    <b>CBCE</b>

## Features at a Glance:

High efficiency **94%** and high reliability

Environmentally friendly, compact and quiet

Slim (86mm), Installed on DIN rail TS35 / 7.5 or 15

Built-in: active PFC function, PF>0.94, constant current limiting circuit & DC OK relay contact

Working temperature ranging from -20° C~+70° C

Protections: Short circuit / Over load /  
Over voltage / Over temp.

LED indicator for power on

Cooling by fan-less natural (free air) convection

Complies with **GL** for marine and **SEMI F47** for semi-conductor fabrication equipment

Safety standards: UL508 (industrial control equipment)  
TUV EN60950-1 approved and EN61000-6-2  
(EN50082-2) industrial immunity level

MTBF hours: 112.9Khrs *MIL-HDBK-217F (25°C)*

3 year warranty

Case: 984A

Weight: 3.5 Lbs. (1.6 Kgs)

Dimensions: 3.4" W x 4.9" H x 5.0" D  
85.5\*125.2\*128.5mm (W\*H\*D)



The compact **C-SDR 480** Series are industrial DIN rail power supplies with 94% efficiency and built-in protections against short circuits, over loads, over voltage and over temperature. This power supply is ideal for PoE and PoE Plus applications because it provides 48 volts and 480 watts to power multiple high-power devices. With UL 508 (industrial control equipment) approval and a wide operating temperature range C-SDR-480 is reliable in even the most demanding environments. Complies with **GL** for marine and **SEMI F47** for semi-conductor fabrication equipment. Perfect in low noise (fan-less) applications.

Recommended with [TAC60™ enclosure air conditioners](#) and [TACE™ series enclosures](#) and in telecom, factory automation and electro-mechanical applications.

Pricing	1 ~ 9	\$ 338.00
	10+	\$ 307.50
	25+	\$ 289.00

POLLOCK INDUSTRIES, INC. 81 Butternut Road, White River, VT 05001

toll-free 1-866-665-5434 (603) 888-2467 sales@pollock.biz

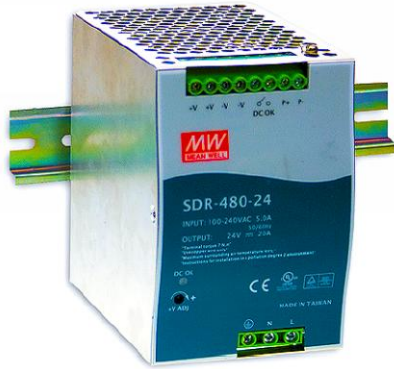

■ Features :

- High efficiency 94% and low power dissipation
- 150% peak load capability
- Built-in active PFC function, PF>0.94
- Protections: Short circuit / Overload / Over voltage / Over temperature
- Cooling by free air convection
- Built-in constant current limiting circuit
- Can be installed on DIN rail TS-35/7.5 or 15
- UL 508(industrial control equipment)approved
- EN61000-6-2(EN50082-2) industrial immunity level
- Built-in DC OK relay contact
- 100% full load burn-in test
- 3 years warranty



**SPECIFICATION**

MODEL		SDR-480-24	SDR-480-48
OUTPUT	DC VOLTAGE	24V	48V
	RATED CURRENT	20A	10A
	CURRENT RANGE	0 ~ 20A	0 ~ 10A
	RATED POWER	480W	480W
	PEAK CURRENT	30A	15A
	PEAK POWER <small>Note.6</small>	720W (3sec.)	
	RIPPLE & NOISE (max.) <small>Note.2</small>	100mVp-p	120mVp-p
	VOLTAGE ADJ. RANGE	24 ~ 28V	48 ~ 55V
	VOLTAGE TOLERANCE <small>Note.3</small>	±1.2%	±1.0%
	LINE REGULATION	±0.5%	±0.5%
	LOAD REGULATION	±1.0%	±1.0%
	SETUP, RISE TIME	1500ms, 150ms/230VAC	3000ms, 150ms/115VAC at full load
HOLD UP TIME (Typ.)	14ms/230VAC at full load		
INPUT	VOLTAGE RANGE <small>Note.7</small>	90 ~ 264VAC 127 ~ 370VDC	
	FREQUENCY RANGE	47 ~ 63Hz	
	POWER FACTOR (Typ.)	0.94/230VAC 0.99/115VAC at full load	
	EFFICIENCY (Typ.)	94%	
	AC CURRENT (Typ.)	5A/115VAC 2.5A/230VAC	
	INRUSH CURRENT (Typ.)	40A/115VAC 80A/230VAC	
	LEAKAGE CURRENT	<0.8mA / 240VAC	
PROTECTION	OVERLOAD	Normally works within 110 ~ 150% rated output power for more than 3 seconds and then shut down o/p voltage with auto-recovery >150% rated power, constant current limiting with auto-recovery within 2 seconds and may cause to shut down if over 2 seconds	
	OVER VOLTAGE	29 ~ 33V	56 ~ 65V
	OVER TEMPERATURE	105°C ±5°C (TSW : detect on heatsink of power switch) Protection type : Shut down o/p voltage, recovers automatically after temperature goes down	
FUNCTION	DC OK REALY CONTACT RATINGS (max.)	60Vdc/0.3A, 30Vdc/1A, 30Vac/0.5A resistive load	
ENVIRONMENT	WORKING TEMP. <small>Note.5</small>	-25 ~ +70°C (Refer to "Derating Curve")	
	WORKING HUMIDITY	20 ~ 95% RH non-condensing	
	STORAGE TEMP., HUMIDITY	-40 ~ +85°C, 10 ~ 95% RH	
	TEMP. COEFFICIENT	±0.03%/°C (0 ~ 50°C)	
	VIBRATION	Component:10 ~ 500Hz, 2G 10min./1cycle, 60min. each along X, Y, Z axes; Mounting: Compliance to IEC60068-2-6	
SAFETY & EMC <small>(Note 4)</small>	SAFETY STANDARDS	UL508, TUV EN60950-1 approved	
	WITHSTAND VOLTAGE	I/P-O/P:3KVAC I/P-FG:1.5KVAC O/P-FG:0.5KVAC O/P-DC OK:0.5KVAC	
	ISOLATION RESISTANCE	I/P-O/P, I/P-FG, O/P-FG:>100M Ohms / 500VDC / 25°C / 70% RH	
	EMC EMISSION	Compliance to EN55022 (CISPR22) Class B, EN61000-3-2,-3	
OTHERS	EMC IMMUNITY	Compliance to EN61000-4-2,3,4,5,6,8,11, EN55024, EN61000-6-2 (EN50082-2), EN61204-3, heavy industry level, criteria A, SEMI F47, GL approved	
	MTBF	112.9Khrs min. MIL-HDBK-217F (25°C)	
	DIMENSION	85.5*125.2*128.5mm (W*H*D)	
	PACKING	1.6Kg; 8pcs/13.8Kg/0.9CUFT	
NOTE	<ol style="list-style-type: none"> <li>1. All parameters NOT specially mentioned are measured at 230VAC input, rated load and 25°C of ambient temperature.</li> <li>2. Ripple &amp; noise are measured at 20MHz of bandwidth by using a 12" twisted pair-wire terminated with a 0.1uf &amp; 47uf parallel capacitor.</li> <li>3. Tolerance : includes set up tolerance, line regulation and load regulation.</li> <li>4. The power supply is considered a component which will be installed into a final equipment. The final equipment must be re-confirmed that it still meets EMC directives.</li> <li>5. Installation clearances : 40mm on top, 20mm on the bottom, 5mm on the left and right side are recommended when loaded permanently with full power. In case the adjacent device is a heat source, 15mm clearance is recommended.</li> <li>6. 3 seconds peak power max. and the average output power should not exceed the rate power.</li> <li>7. Derating may be needed under low input voltage. Please check the derating curve for more details.</li> </ol>		



**Mechanical Specification**

Case No.984A Unit:mm

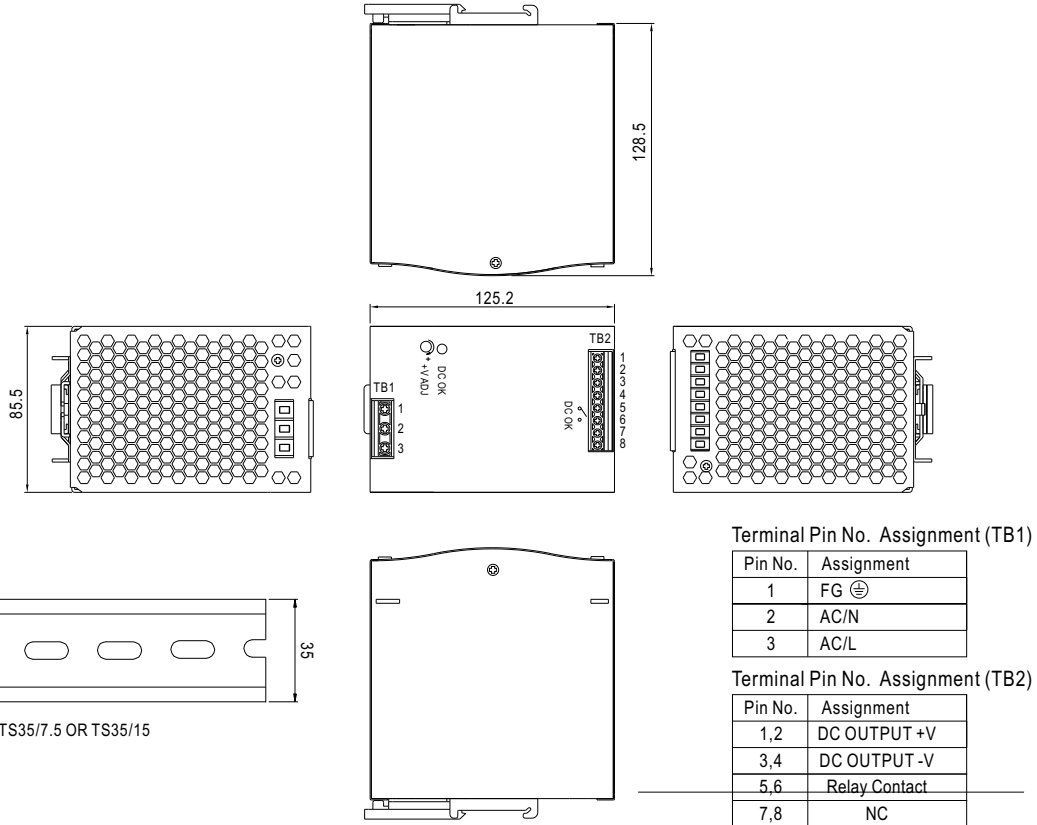

ADMISSIBLE DIN-RAIL: TS35/7.5 OR TS35/15

**Block Diagram**

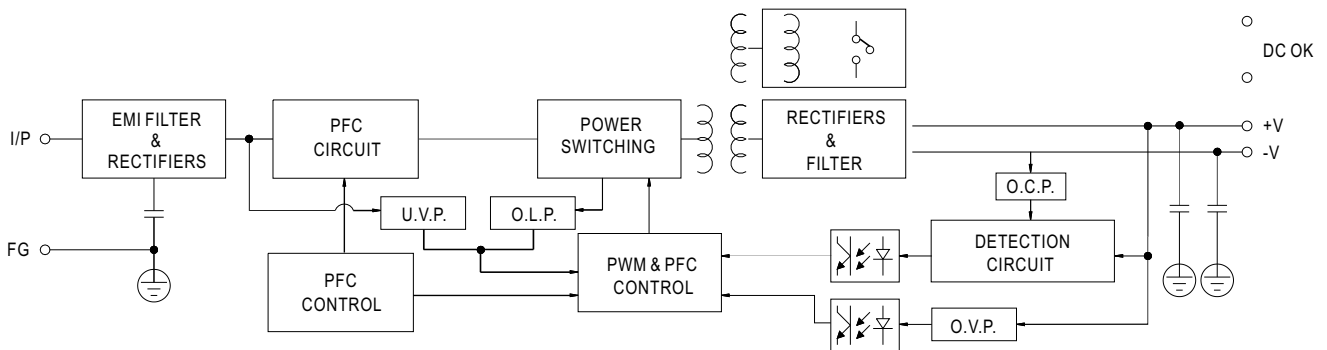

**DC OK Relay Contact**

Contact Close	PSU turns on / DC OK.
Contact Open	PSU turns off / DC Fail.
Contact Ratings (max.)	30V/1A resistive load.



■ Peak Loading

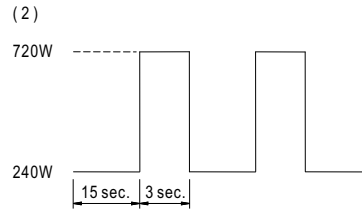
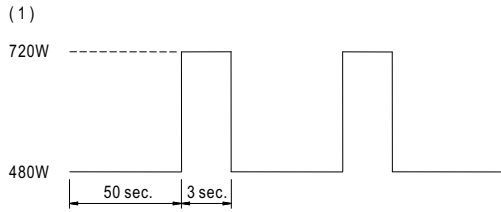

■ Derating Curve

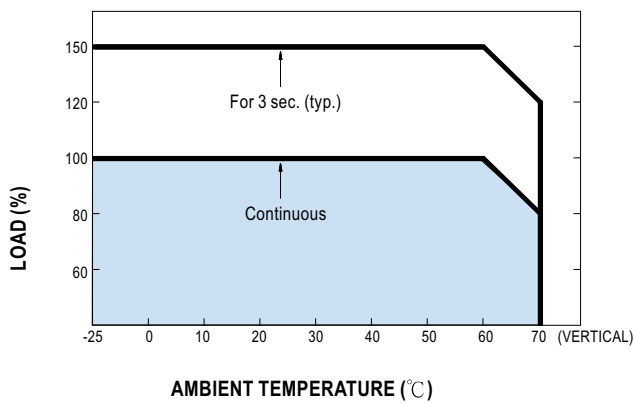

■ Output derating VS input voltage

