



Compact 960W 48V Single Output DIN RAIL Power Supply with PFC

UNIT CODE	DESCRIPTION
C-SDR 960-48	960 Watt, 48V, Single Output, Compact DIN RAIL Power Supply with PFC and Parallel Functions

SPECIFICATIONS		
AC Input	Output	Approvals
Single Phase 230VAC (180~264VAC Input Range)	+48VDC @ 0~20A	Parallel    CBCE

Features at a Glance:

- AC input 180~264VAC only
- Current sharing up to 3,840W (3+1) 
- High efficiency 94% and low power dissipation
- Built-in: active PFC function (PF>0.94); constant current limiting circuit & DC OK relay contact
- Slim 110mm Installed on DIN rail TS35 / 7.5 or 15
- Protections: Short circuit, Overload, Over voltage and Over temperature
- 130% peak load capability for 3 seconds
- Front panel DC voltage adjustment
- LED indicator for power ON
- DC OK relay contact
- Quiet - Cooling by natural (free air) convection
- 100% full load burn-in test & 3 year warranty
- Safety standards: UL508, TUV EN60950-1, EN61000-6-2(EN50082-2) industrial immunity
- Certificates: UL / CUL / TUV / CB / CE
- MTBF hours: 69.8K hrs. MIL-HDBK-217F (25°C)
- Case: 214A
- Weight: 5.4 Lbs. (2.47 Kgs)
- Dimensions: 4.3" W x 4.9" H x 5.9" D
110 x 125.2 x 150mm (W*H*D)
- 3 year warranty



C-SDR960 fulfills the requirement for a high power, slim industrial DIN rail power supply with PFC, that has a compact design (110mm wide), is highly efficient (94%) and quiet.

The C-SDR960 Series features a built-in, active PFC function and a 180~264VAC input range can be used in general power system with single phase 230VAC input. It can be operated at the full load of 960W at up ambient temperatures up +50°C (or up to +70°C with some power derating). Other standard functions include DC OK relay contact alarm signal output, parallel function (up to 4 units), front panel DC voltage adjustment (100~115%), front panel LED indicator, as well as protections for short-circuit, overload, over voltage, and over temperature.

Suitable applications include industrial control systems, semi-conductor fabrication equipment, factory automation, electro-mechanical applications, and any installation with fan-less or low noise requirements.

Pricing	1 ~ 9	\$ 499.00
	10+	\$ 459.00
	25+	\$ 415.00

[Release & Application Notes](#)

■ Features :

- AC input 180~264VAC only
- 130% peak load capability
- 110mm slim design
- Built-in active PFC function compliance to EN61000-3-2
- High efficiency 94% and low power dissipation
- Protections: Short circuit / Overload / Over voltage / Over temperature
- Cooling by free air convection
- Built-in constant current limiting circuit
- Can be installed on DIN rail TS-35/7.5 or 15
- UL508(industrial control equipment)approved
- EN61000-6-2(EN50082-2) industrial immunity level
- Current sharing up to 3840W(3+1)
- Built-in DC OK relay contact
- 100% full load burn-in test
- 3 years warranty

SPECIFICATION

MODEL		SDR-960-24	SDR-960-48
OUTPUT	DC VOLTAGE	24V	48V
	RATED CURRENT	40A	20A
	CURRENT RANGE	0 ~ 40A	0 ~ 20A
	RATED POWER	960W	960W
	PEAK CURRENT	52A	26A
	PEAK POWER <small>Note.6</small>	1248W (3sec.)	
	RIPPLE & NOISE (max.) <small>Note.2</small>	180mVp-p	250mVp-p
	VOLTAGE ADJ. RANGE	24 ~ 28V	48 ~ 55V
	VOLTAGE TOLERANCE <small>Note.3</small>	±1.0%	±1.0%
	LINE REGULATION	±0.5%	±0.5%
	LOAD REGULATION	±1.0%	±1.0%
	SETUP, RISE TIME	1000ms, 100ms/230VAC at full load	
HOLD UP TIME (Typ.)	14ms / 230VAC at full load		
INPUT	VOLTAGE RANGE <small>Note.7</small>	180 ~ 264VAC 254 ~ 370VDC	
	FREQUENCY RANGE	47 ~ 63Hz	
	POWER FACTOR (Typ.)	PF ≥ 0.95/230VAC at full load	
	EFFICIENCY (Typ.)	94%	94%
	AC CURRENT (Typ.)	6A/230VAC	
	INRUSH CURRENT (Typ.)	COLD START 50A / 230VAC	
LEAKAGE CURRENT	<3.5mA / 240VAC		
PROTECTION	OVERLOAD	Normally works within 105 ~ 130% rated output power for more than 3 seconds and then shut down o/p voltage with auto-recovery after 30 seconds if the peak load condition is removed Constant current limiting within 130 ~ 150% rated output power for more than 3 seconds and then shut down o/p voltage, re-power on to recover	
	OVER VOLTAGE	29 ~ 33V	56 ~ 65V
	OVER TEMPERATURE	90°C ±5°C (TSW) detect on heatsink of power switch Protection type : Shut down o/p voltage, recovers automatically after temperature goes down	
FUNCTION	DC OK RELAY CONTACT RATINGS (max.)	60Vdc/0.3A, 30Vdc/1A, 30Vac/0.5A resistive load	
	CURRENT SHARING	Please refer to function manual	
ENVIRONMENT	WORKING TEMP. <small>Note.5</small>	-30 ~ +70°C (Refer to "Derating Curve")	
	WORKING HUMIDITY	20 ~ 95% RH non-condensing	
	STORAGE TEMP., HUMIDITY	-40 ~ +85°C, 10 ~ 95% RH	
	TEMP. COEFFICIENT	±0.03%/°C (0 ~ 50°C)	
	VIBRATION	Component:10 ~ 500Hz, 2G 10min./1cycle, 60min. each along X, Y, Z axes; Mounting: Compliance to IEC60068-2-6	
SAFETY & EMC <small>(Note 4)</small>	SAFETY STANDARDS	UL508, TUV EN60950-1 approved	
	WITHSTAND VOLTAGE	I/P-O/P:3KVAC I/P-FG:2KVAC O/P-FG:0.5KVAC O/P-DC OK:0.5KVAC	
	ISOLATION RESISTANCE	I/P-O/P, I/P-FG, O/P-FG:>100M Ohms / 500VDC / 25°C / 70% RH	
	EMC EMISSION <small>Note.8</small>	Compliance to EN55022 (CISPR22), EN61204-3 Conduction class B, Radiation class A, EN61000-3-2,-3	
OTHERS	EMC IMMUNITY	Compliance to EN61000-4-2,3,4,5,6,8,11, EN55024, EN61000-6-2 (EN50082-2), EN61204-3, heavy industry level, criteria A	
	MTBF	69.8K hrs min. MIL-HDBK-217F (25°C)	
	DIMENSION	110*125.2*150mm (W*H*D)	
NOTE	PACKING	2.47Kg ; 6pcs/15.8Kg/1.55CUFT	
	NOTE	1. All parameters NOT specially mentioned are measured at 230VAC input, rated load and 25°C of ambient temperature. 2. Ripple & noise are measured at 20MHz of bandwidth by using a 12" twisted pair-wire terminated with a 0.1uf & 47uf parallel capacitor. 3. Tolerance : includes set up tolerance, line regulation and load regulation. 4. The power supply is considered a component which will be installed into a final equipment. The final equipment must be re-confirmed that it still meets EMC directives. 5. Installation clearances : 40mm on top, 20mm on the bottom, 5mm on the left and right side are recommended when loaded permanently with full power. In case the adjacent device is a heat source, 15mm clearance is recommended. 6. 3 seconds peak power max. and the average output power should not exceed the rate power. 7. Derating may be needed under low input voltage. Please check the derating curve for more details. 8. Consult MEAN WELL for deployment of Radiation class B.	

POLLOCK INDUSTRIES, INC. (603) 888-2467 sales@pollock.biz

POLLOCK INDUSTRIES



960W Single Output Industrial DIN RAIL with PFC Function

SDR-960 series

Mechanical Specification

Case No.214A Unit:mm

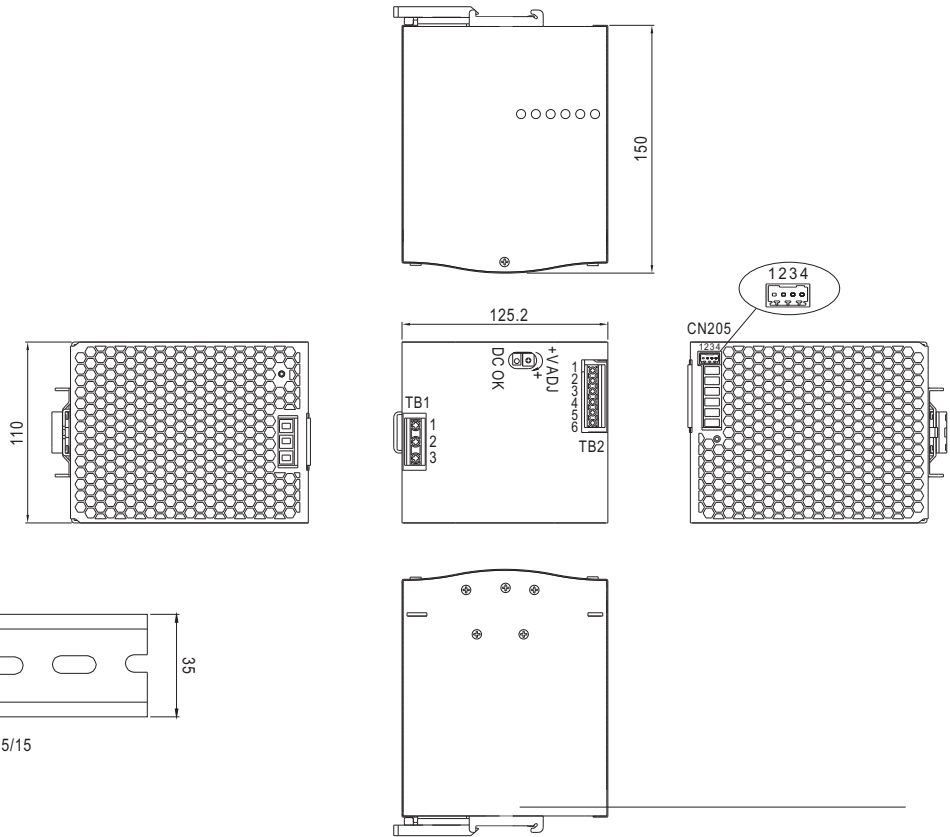

ADMISSIBLE DIN-RAIL: TS35/7.5 OR TS35/15

Terminal Pin No. Assignment (TB1)

Pin No.	Assignment
1	FG ⊕
2	AC/N
3	AC/L

Terminal Pin No. Assignment (TB2)

Pin No.	Assignment
1,2,3	DC OUTPUT +V
4,5,6	DC OUTPUT -V

Control Pin (CN205) : DINKLE ECH250R-04P or equivalent

Pin No.	Assignment	Mating Housing	Wire Diameter
1	P-(Current Share)	DINKLE ESC250V-04P or equivalent (including in the single package)	0.081~0.517mm ² (28~20AWG)
2	P+(Current Share)		
3,4	DC OK Relay Contact		

Block Diagram

PFC fosc : 65KHz
PWM fosc : 60KHz

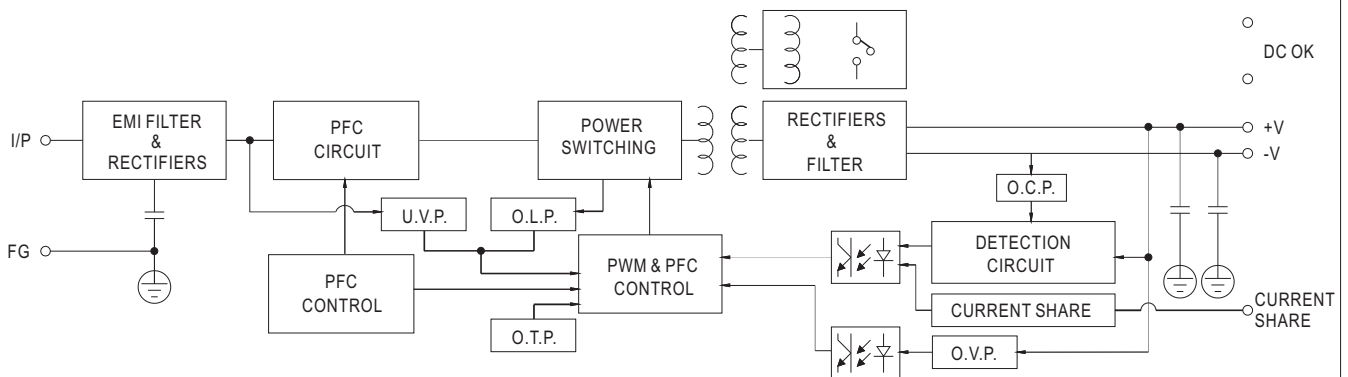

DC OK Relay Contact

Contact Close	PSU turns on / DC OK.
Contact Open	PSU turns off / DC Fail.
Contact Ratings (max.)	30V/1A resistive load.

POLLOCK INDUSTRIES



960W Single Output Industrial DIN RAIL with PFC Function

SDR-960 series

Peak Loading



Derating Curve

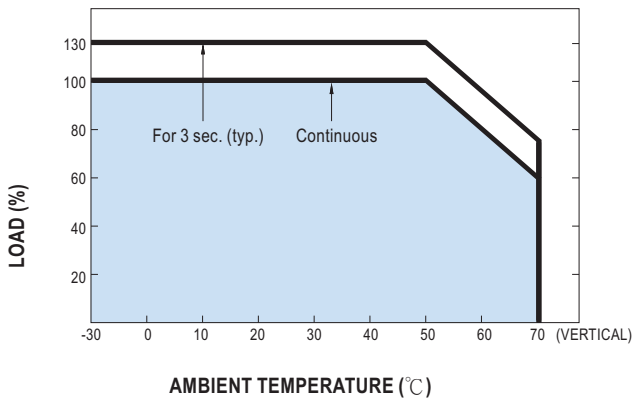

Output derating VS input voltage

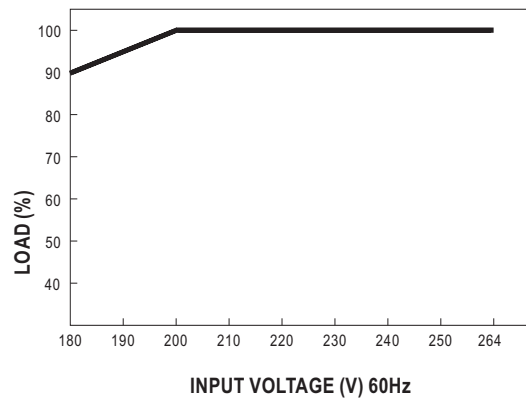

Function Manual

1. Current sharing

- (1) Parallel operation is available by connecting the units shown as below (P+,P- are connected mutually in parallel).
- (2) Difference of output voltages among parallel units should be less than 0.2V.
- (3) The total output current must not exceed the value determined by the following equation (Output current at parallel operation)=(The rated current per unit) x (Number of unit) x 0.9.
- (4) In parallel operation 4 units is the maximum, please consult the manufacture for other applications.
- (5) The power supplies should be paralleled using short and large diameter wiring and then connected to the load.
- (6) When in parallel operation, the minimum output load should be greater than 5% of total output load.
(Min. load >5% rated current per unit x number of unit)
- (7) In parallel connection, maybe only one unit (master) operate if the total output load is less than 5% of rated load condition.
The other PSUs (slaves) may go into standby mode and their output LEDs & relays will not turn on.
- (8) Some minor noise may be heard at light load condition under parallel operation.
This is a normal phenomenon and the performance of the PSU will not be influenced.

