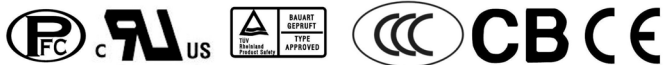

100 Watt 24 Volt, 1U Low Profile, Single Output, Power Supply with PFC

UNIT CODE	DESCRIPTION
PS-RSP 100-24	100 Watt, 24V, Single Output, 30mm Low Profile, Enclosed Power Supply with PFC Function

SPECIFICATIONS		
Input	Output	Approvals
Universal 85 ~ 264VAC	+24VDC @ 0 ~ 4.2A	

Features at a Glance:

Priced Economically

Universal AC Input for Worldwide Use

30mm low profile 1U design

Constant current limiting circuit

Efficient (87%) and cooled by natural convection

Active PFC and Remote ON-OFF control

Protections: Short circuit, Overload,
Over voltage, Over temperature

Simple (-5% ~ +10%) output voltage adjustment

LED indicator for Power ON

Safety Standards: UL60950-1, TUV EN60950-1
EN61558-2-16, CCC GB4943

EMC: Light Industry level, criteria A
- See following pages for complete EMC details

Certificates: UL / CUL / TUV / CB / CE / CCC

MBTF: YTBD hours min. MIL-HDBK-217F (25°C)

Case: 227A

Weight: 1.14 lbs. (0.52 Kgs)

Dimensions: 7.04"L x 3.89"W x 1.18"H
179L X 99W X 30mmH

3 year warranty



The PS- RSP 100 series is a general purpose, "light industrial level," AC/DC, low profile (1U), single output, enclosed type, switching power supply with Power Factor Correction (PFC).

Functions include remote ON/OFF control, a constant current limiting circuit, short circuit, overload, over voltage, and over temperature protections. Users can make a (-5% ~ +10%) output voltage adjustment on a small rheostat on the terminal strip. The series meet requirements from UL, CUL, TUV, CCC, CB, and are approved for use in the European household appliance market. PS-RSP-100 is also CCC approved (China Compulsory Certification).

The PS-RSP-100 Series is widely used and applications include general automation and control systems, mechanical and electrical equipment, instrumentation, household appliances or systems that require an economical but reasonably efficient 100 Watt supply with a 1U low profile.

[Click for more information](#)

Pricing: 1+ \$ 99.00
10+ 92.50
25+ 87.00

toll-free 1-866-665-5434 (603) 888-2467 power@electracool.com

RSP 100-24

100 Watt, 24 Volt, 1U Low Profile,
Single Output, Power Supply with PFC

POLLOCK INDUSTRIES

Specifications

OUTPUT

DC VOLTAGE	24 V
RATED CURRENT	4.2 A
CURRENT RANGE	0 ~ 4.2A
RATED POWER	100.8W
RIPPLE & NOISE (max.) <i>Note.2</i>	150mVp-p
VOLTAGE ADJ. RANGE	22.8 ~ 26.4V
VOLTAGE TOLERANCE <i>Note.3</i>	±1.0%
LINE REGULATION	±0.5%
LOAD REGULATION	±0.5%
SETUP, RISE TIME	600ms, 30ms at full load
HOLD UP TIME (Typ.)	16ms at full load

INPUT

VOLTAGE RANGE	85 ~ 264VAC	120 ~ 370VDC
FREQUENCY RANGE	47 ~ 63Hz	
POWER FACTOR (Typ.)	PF>0.93/230VAC	PF>0.98/115VAC at full load
EFFICIENCY (Typ.)	87%	
AC CURRENT (Typ.)	1.1A/115VAC	0.55A/230VAC
INRUSH CURRENT (Typ.)	COLD START 30A/230VAC	
LEAKAGE CURRENT	<2mA / 240VAC	

PROTECTION

OVERLOAD	105 ~ 135% rated output power. Protection type: Constant current limiting, recovers automatically after fault removed
OVER VOLTAGE	26.4 ~ 32.4V Protection type: Shut down o/p voltage, re-power on to recover
OVER TEMPERATURE	Shut down o/p voltage, recovers automatically after temperature drops

ENVIROMENT

WORKING TEMP.	-30°C ~ +70°C (Refer to the "Derating Curve" on last page)
WORKING HUMIDITY	20 ~ 90% RH non-condensing
STORAGE TEMP., HUMIDITY	-40°C ~ +85°C, 10 ~ 95% RH
TEMP. COEFFICIENT	±0.05%/°C (0 ~ 50 °C)
VIBRATION	10 ~ 500Hz, 2G 10min./1cycle, 60min. each along X, Y, Z axes

SAFETY & EMC *Note.4*

SAFETY STANDARDS	UL60950-1, TUV EN60950-1, EN61558-1, EN61558-2-16, CCC GB4943 approved
WITHSTAND VOLTAGE	I/P-O/P: 3.75KVAC I/P-FG: 2KVAC O/P-FG: 0.5KVAC
ISOLATION RESISTANCE	I/P-O/P, I/P-FG, O/P-FG:100M Ohms /500VDC / 25°C / 70% RH
EMC EMISSION	Compliance to EN55022 (CISPR22) Class B, EN61000-3-2, 3, GB9254 class B
EMC IMMUNITY	Compliance to EN61000-4-2,3,4,5,6,8,11, EN55024, light industry level, criteria A

OTHER

REMOTE CONTROL FUNCTION:	CN1: <0~0.8 VDC Power ON, 4 ~10VDC Power OFF
MTBF	288K hrs min. MIL-HDBK-217F (25 °C)
DIMENSIONS	179*99*30mm (L*W*H)
PACKING	0.52Kg; 24pcs/14.5Kg/0.84CUFT

NOTES: 1. All parameters NOT specifically mentioned are measured at 230VAC input, rated load and ambient temperature of 25°C.
2. Ripple & noise are measured at 20MHz of bandwidth by using a 12" twisted pair-wire terminated with a 0.1uf & 47uf parallel capacitor.
3. Tolerance: includes set up tolerance, line regulation and load regulation.
4. The power supply is considered a component which will be installed into a final piece of equipment. The final equipment must be re-confirmed as still meeting EMC directives. For guidance on how to perform these EMC tests, please Google "EMI testing of component power supplies."

toll-free 1-866-665-5434 (603) 888-2467 power@electracool.com

RSP 100-24

100 Watt, 24 Volt, 1U Low Profile,
Single Output, Power Supply with PFC

POLLOCK INDUSTRIES

Mechanical Specification

Case No.227A Unit:mm

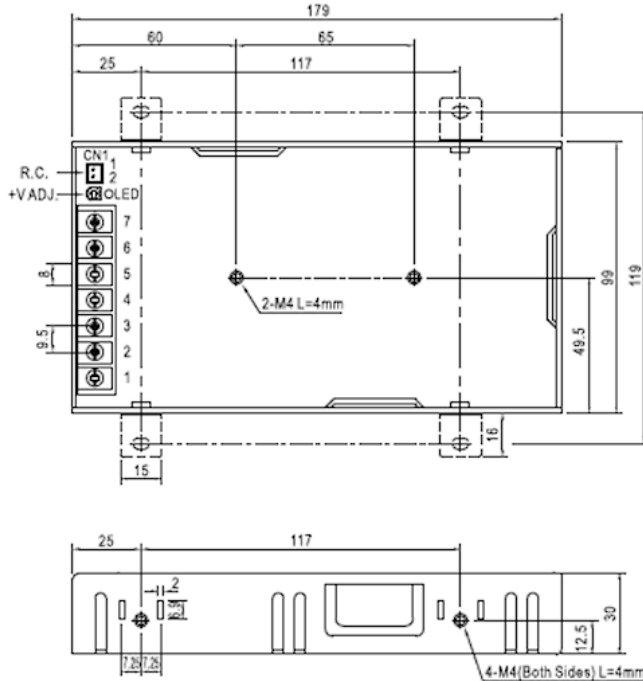

Terminal Pin No. Assignment

Pin No.	Assignment	Pin No.	Assignment
1	AC/L	4,5	DC OUTPUT -V
2	AC/N	6,7	DC OUTPUT +V
3	FG ↓		

Remote ON/OFF(CN1): JST S2B-XH or equivalent(optional)

Pin No.	Assignment	Mating Housing	Terminal
1	RC+	JST XHP or equivalent	JST SXH-001T-P0.6 or equivalent
2	RC-		

Block Diagram

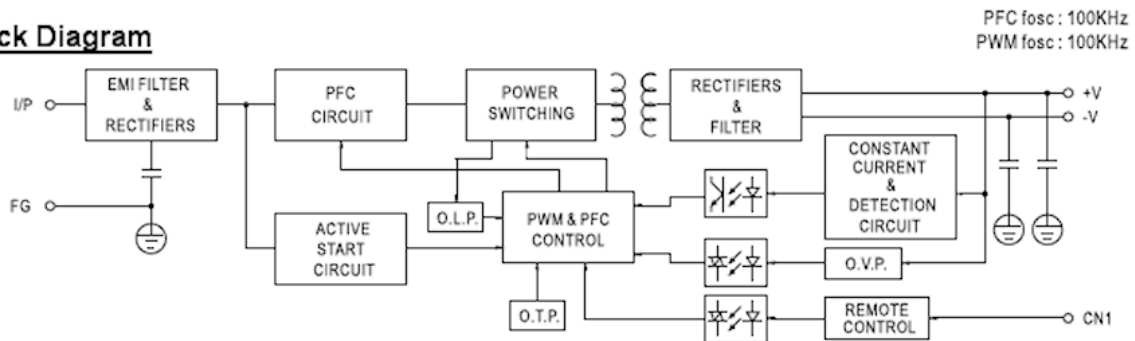

Derating Curve

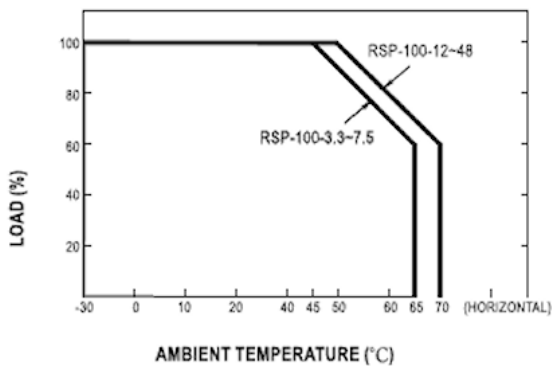

Output Derating vs Input Voltage

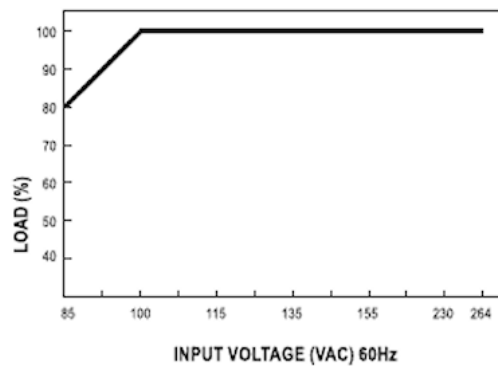

toll-free 1-866-665-5434 (603) 888-2467 power@electracool.com